

## Corporate Presentation

## Sample Work (2019 YTD)



# Company Introduction

MechaFab Industries, based in Houston Texas, is committed to help your Company grow and succeed by supporting your machining and fabrication operations, and producing your most engineered complex components.

MechaFab Industries specializes in the production of custom made parts, weldments, tooling, fixtures, and machinery replacement components to enhance your Manufacturing or Assembly capabilities. We also offer Engineering and Design services to compliment your Manufacturing needs.



# Sample Work – Machining & Assy.

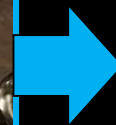

Stainless Steel Flanges & Shafts

# Sample Work – Machining & Assy



Alloy Cement  
Head

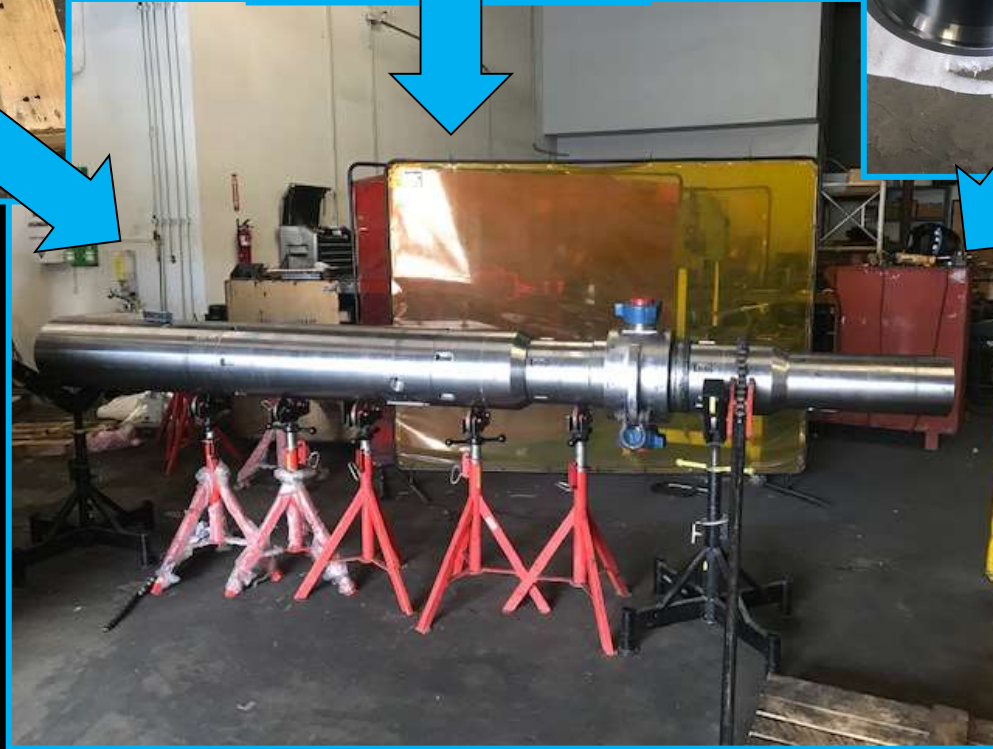

# Sample Work – Machining & Fab. & Assy



Nickel  
Plated  
Weldment



# Sample Work – Machining & Fab. & Assy



Carbon Steel & UHMW Machining  
& Welding & Powder Coating

# Sample Work – Machining

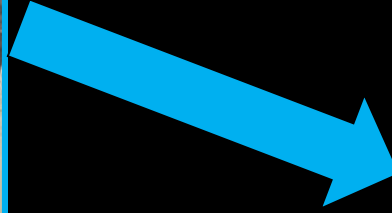

Heat Treated Round Bar

# Sample Work – Machining



Machining & Sinker/Plunge EDM



# Sample Work – Machining

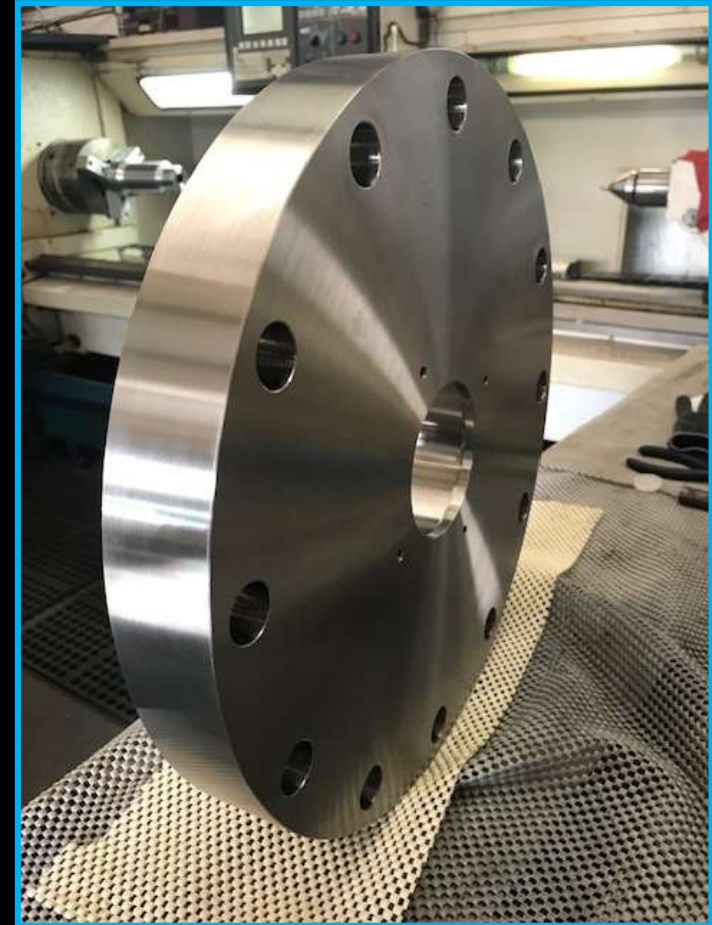

Replacement Hastelloy Flange

# Sample Work – Machining

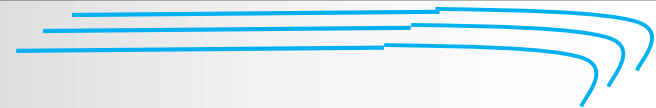

Stainless Steel Flanges & Couplings



# Sample Work – Machining

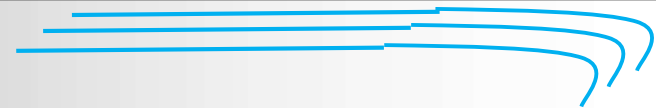

Stainless Steel Molds - Electropolished

# Sample Work – Machining



Misc. Parts – Stainless Steel, and Alloys

# Sample Work – Machining



4140 Alloy Steel Misc. Parts

# Sample Work – Machining

Alloy Steel  
Misc. Parts



# Sample Work – Machining

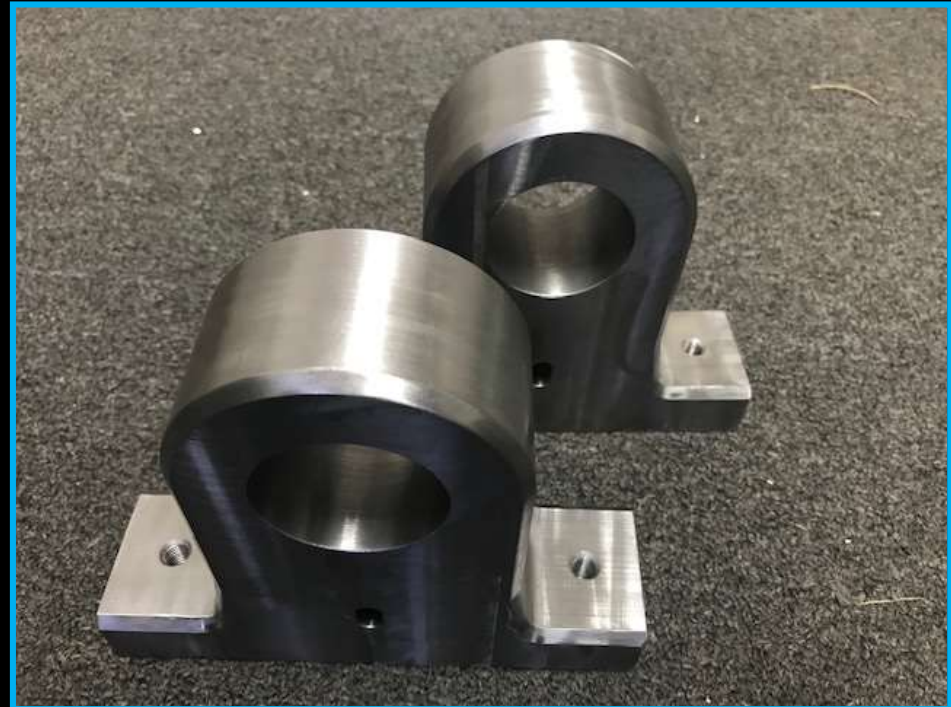
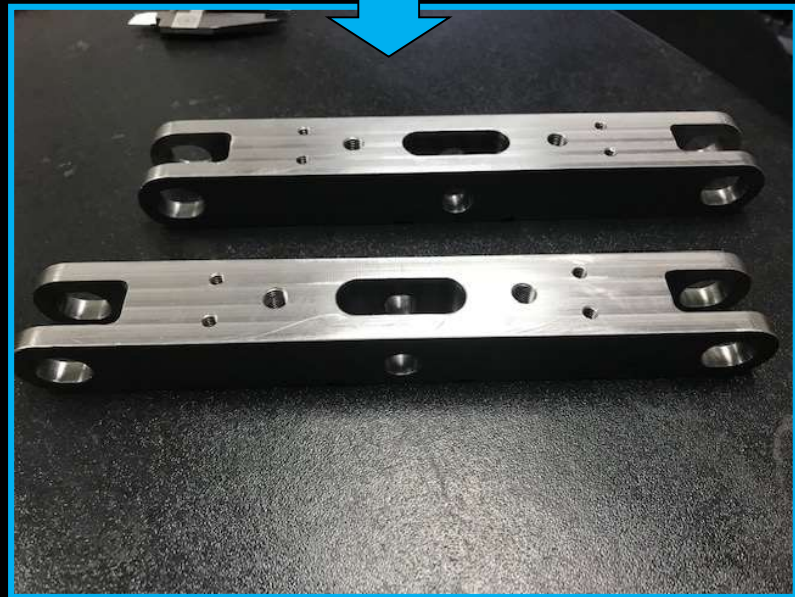
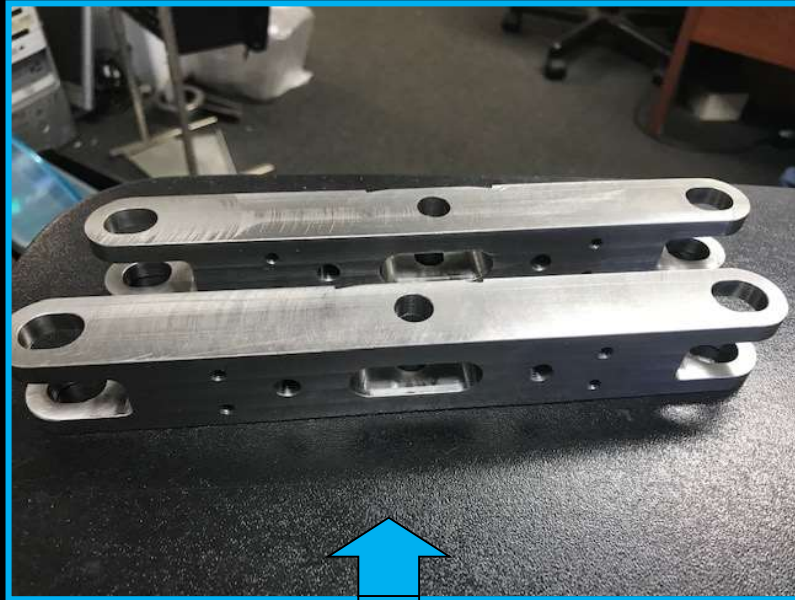
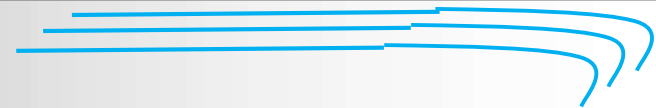

Alloy Misc. Parts

# Sample Work – Machining



Wire EDM & Machining





# Sample Work – Machining & Assy



Brass & Delrin & Aluminum & Alloy Parts

# Sample Work – Machining & Fab.



Carbon Steel  
Cold Welding

# Sample Work – Machining & Fab.

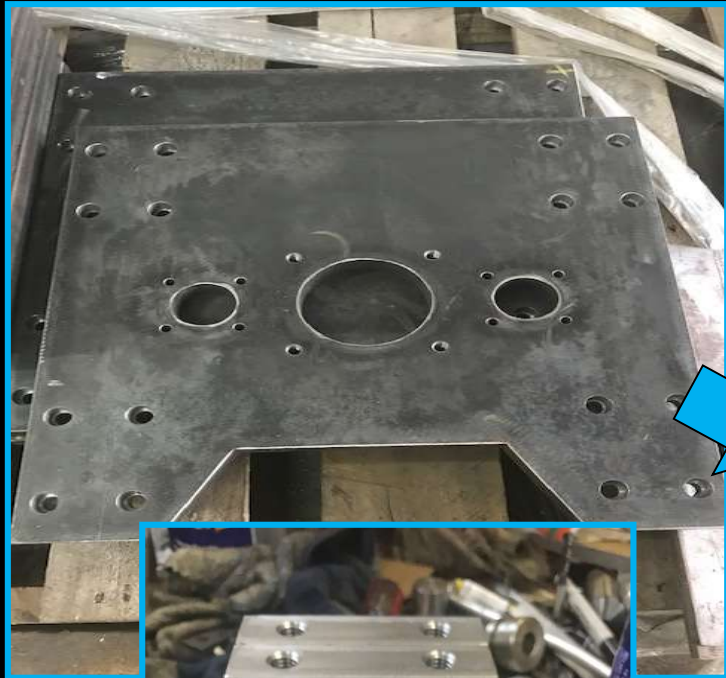

Carbon Steel Plate Cutting & CNC Machining

# Sample Work – Machining & Fab.



Carbon Steel Plate Cutting &  
CNC Machining

# Sample Work – Machining & Fab.

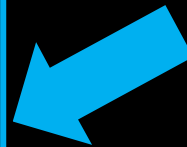
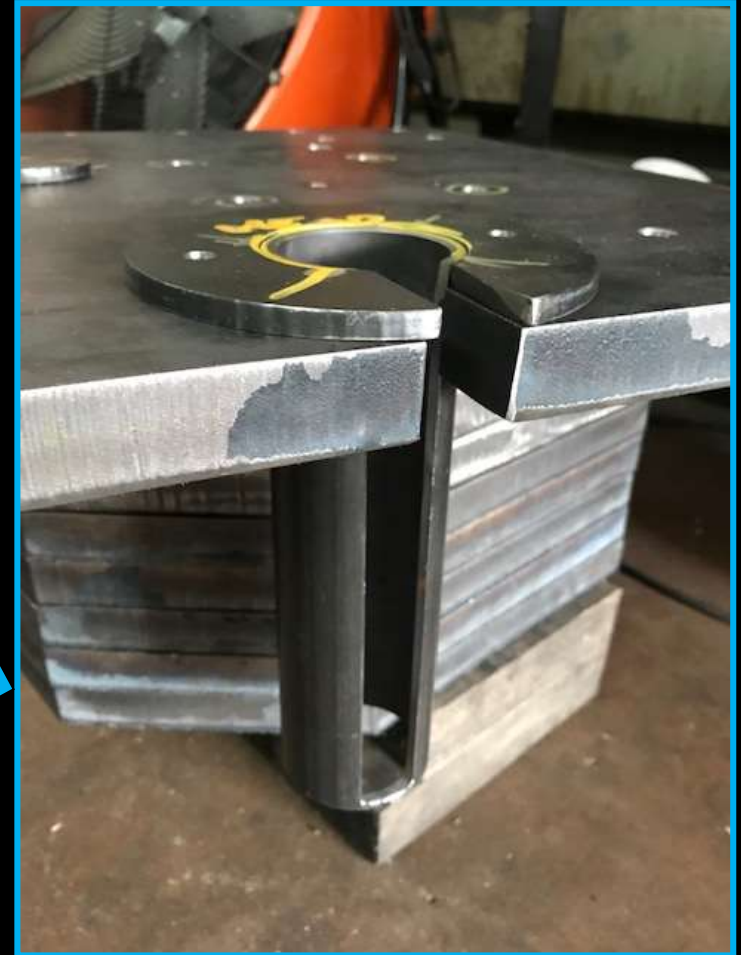
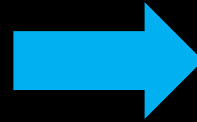

Carbon Steel Plate Cutting & CNC Machining

# Sample Work – Machining & Fab.

Misc. Weldments  
Stainless & Alloy  
& Carbon Steels



## Sample Work – Fabrication

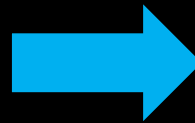

Carbon Steel Plate Cutting & Bending & Welding & Powder Coating

# Sample Work – Machining & Fab.

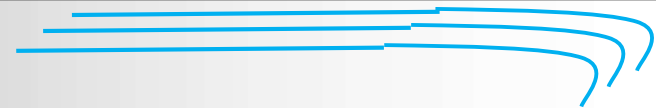

Carbon Steel Plate Cutting & CNC Machining





# Sample Work – Fabrication



Oxyfuel & Water Jet Plate Cutting

# Sample Work – Engineering

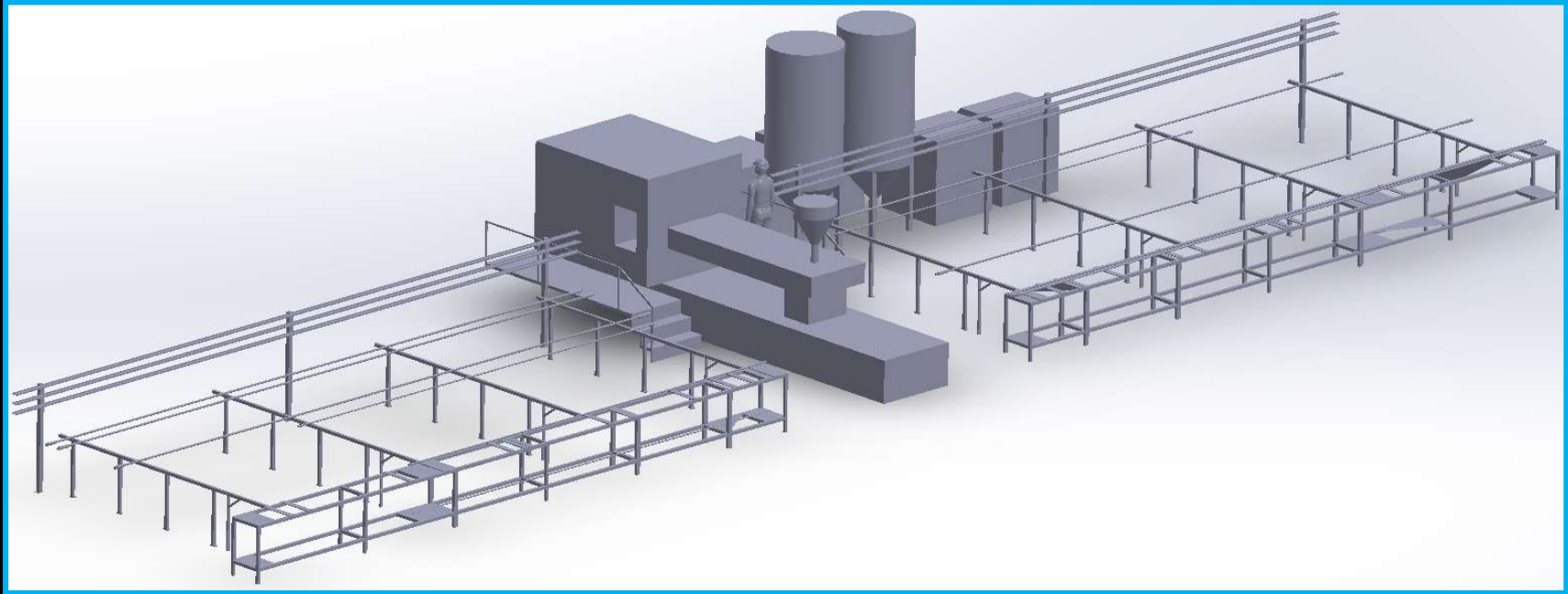

Sucker Rod Guide  
Injection Machine  
Rack System



# Sample Work – Engr. & Machining

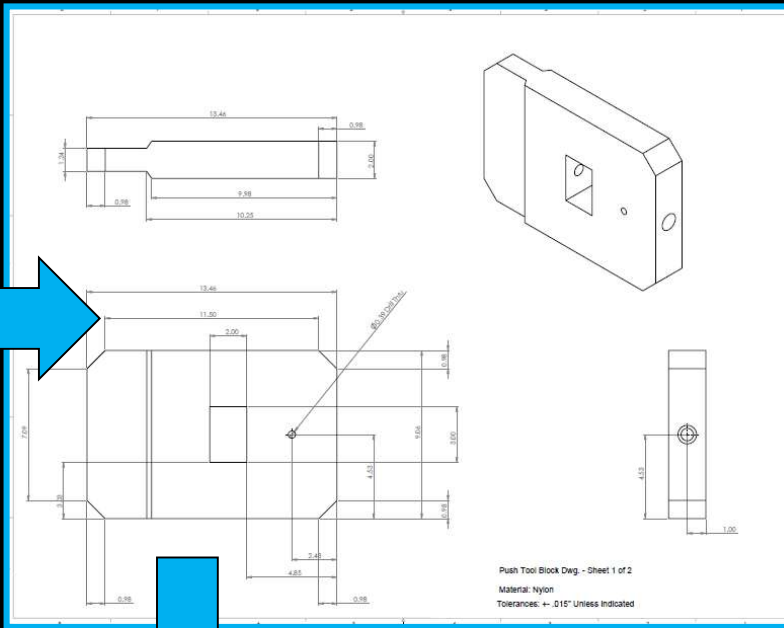
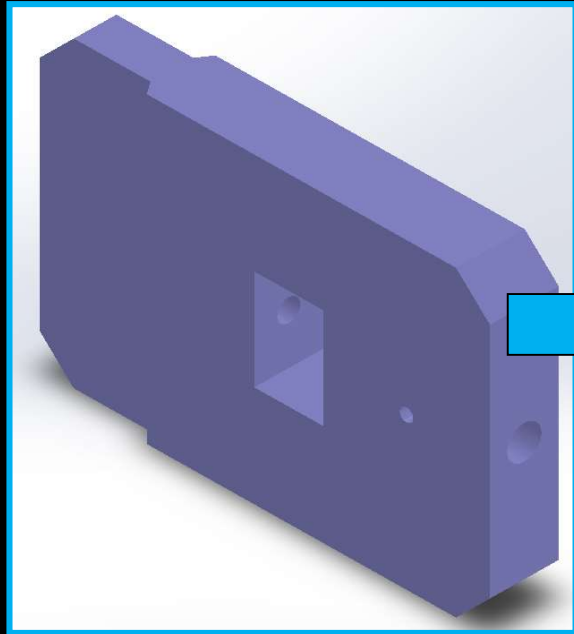

Nylon Push Tool

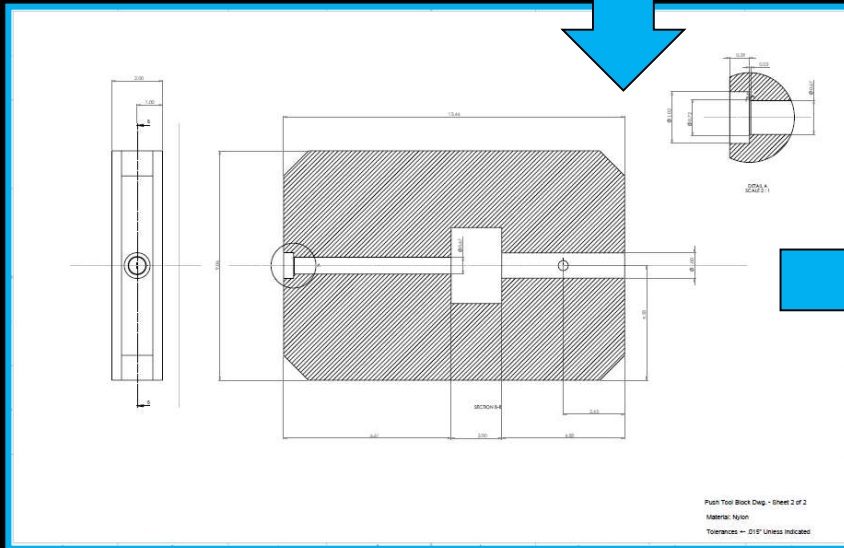

# Sample Work – Engr. & Fabrication

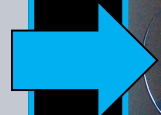
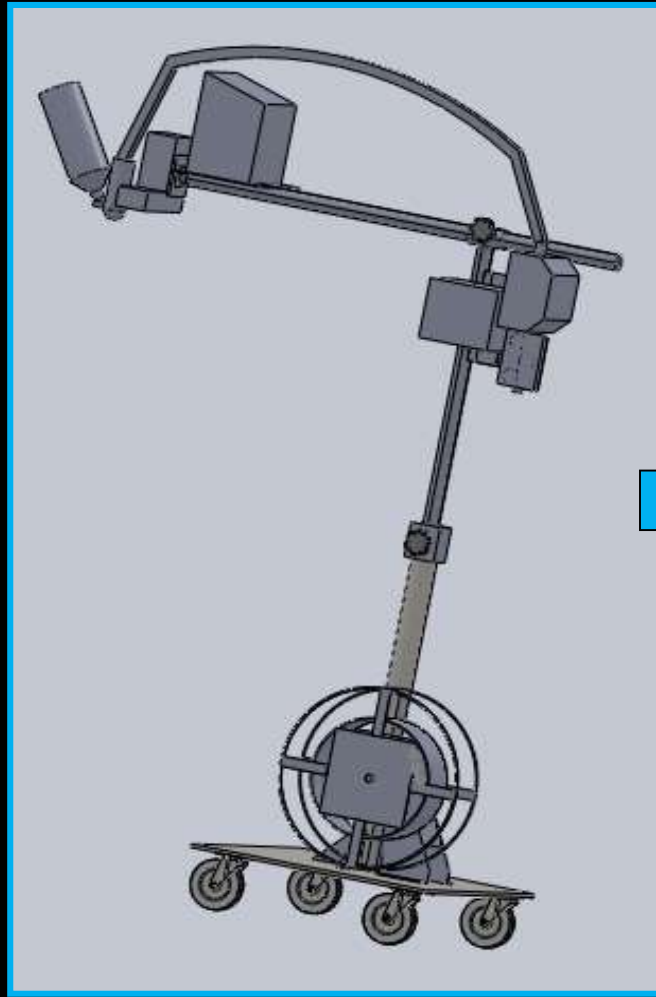

Carbon Steel Welding Positioner Arm  
- Spray Painted

# The End



# Thank you