

Corporate Presentation

Sample Work (2022 YTD)



Company Introduction

MechaFab Industries, based in Houston Texas, is committed to help your Company grow and succeed by supporting your machining and fabrication operations, and producing your most engineered complex components. www.mechafab.com.

MechaFab Industries specializes in the production of custom made parts, weldments, tooling, fixtures, and machinery replacement components to enhance your Manufacturing or Assembly capabilities. We also offer Engineering and Design services to compliment your Manufacturing needs.



Sample Work – Engr. - Mach. – Assy.

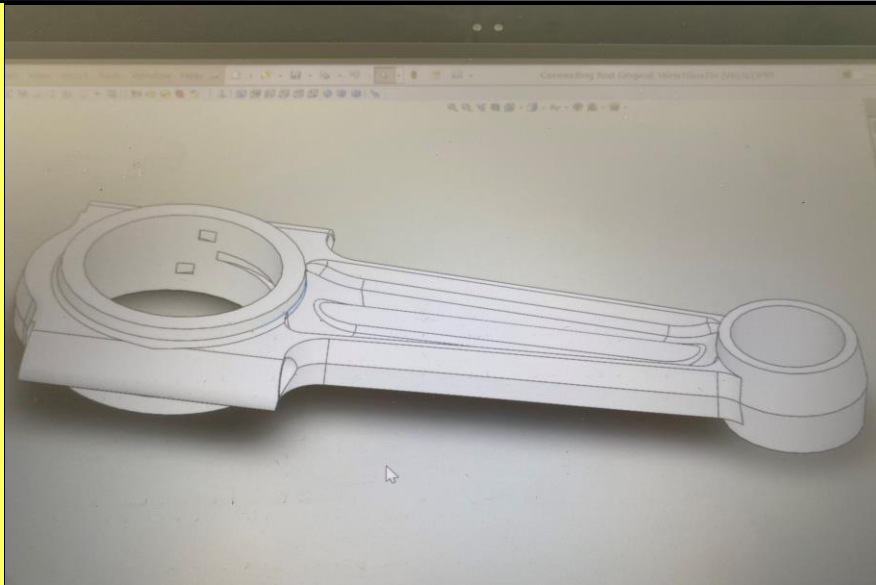

Sample Work – Engr. – Mach. - Anodizing

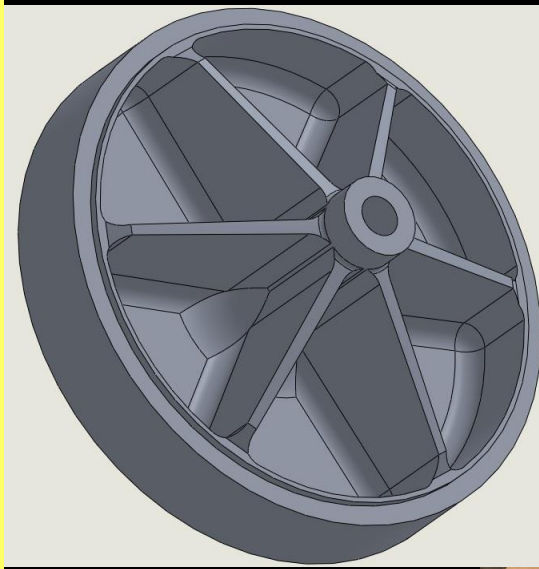

Sample Work – Engr. – Casting Mach.

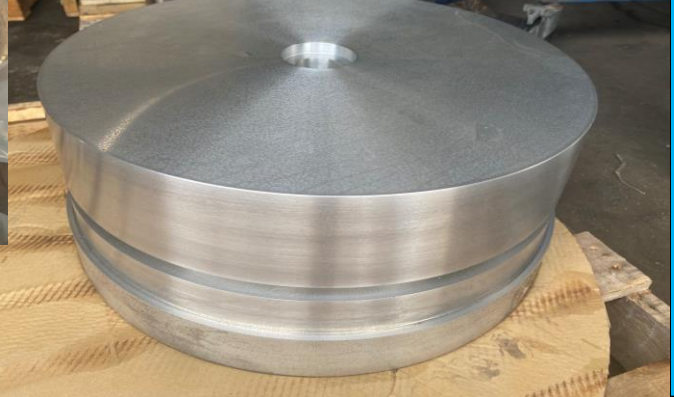
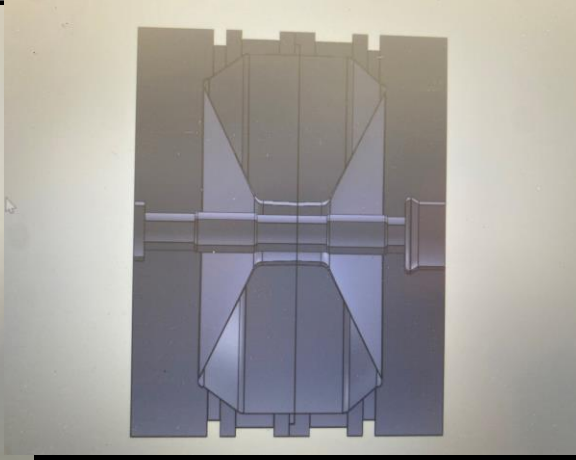
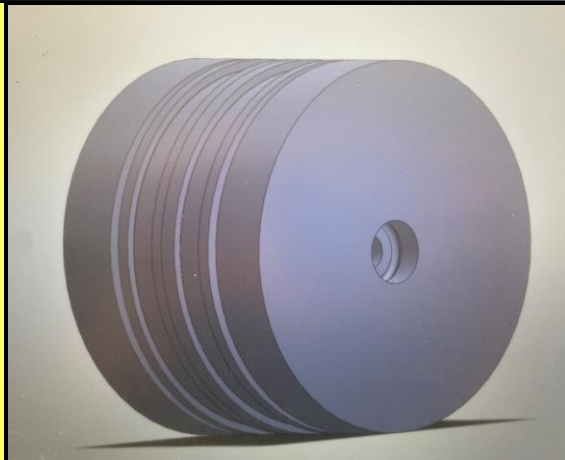

Sample Work – Engr. – Fab. – Mach. – Coat.

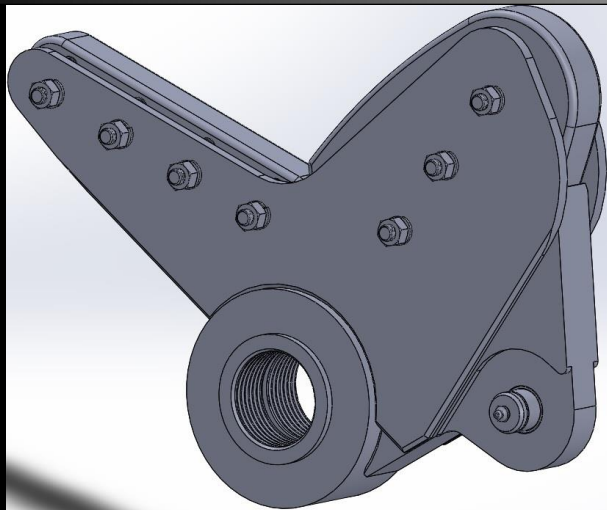

Sample Work – Engr. – Fab. – Mach.

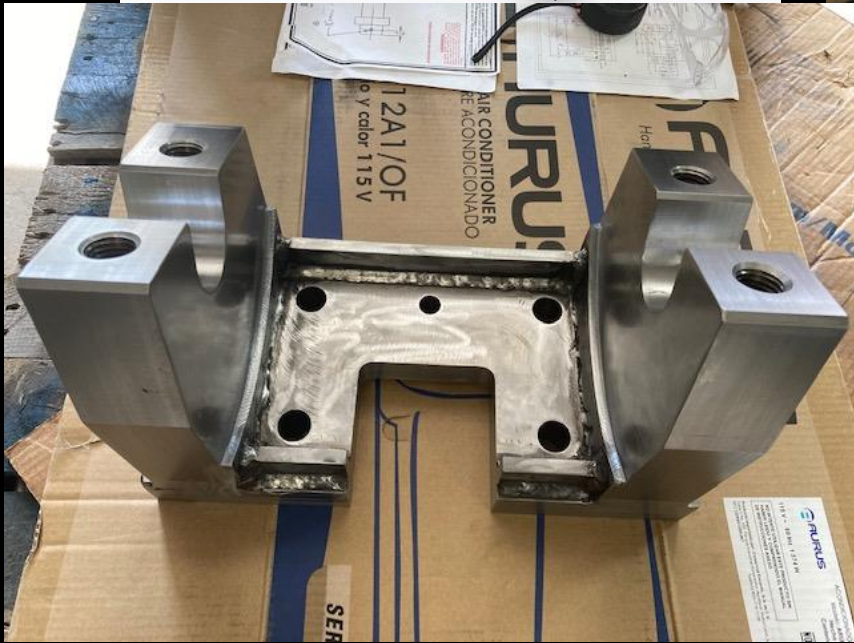
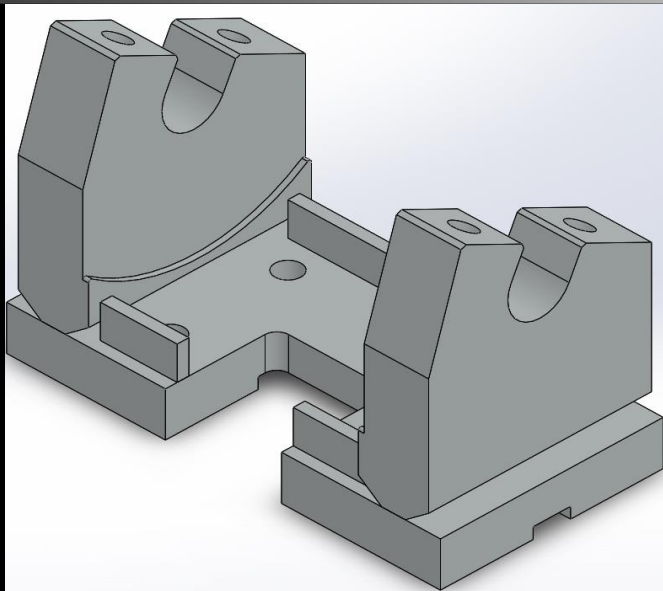

Sample Work – Engr. – Fab. – Mach.

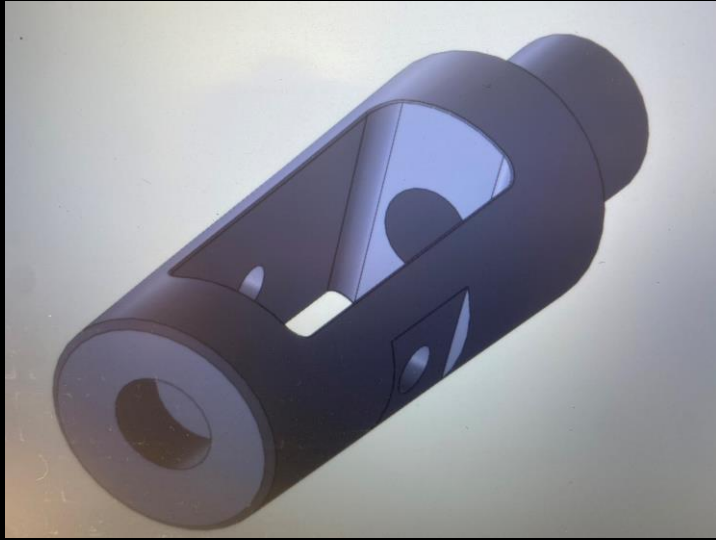

Sample Work – Engr. - Mach.

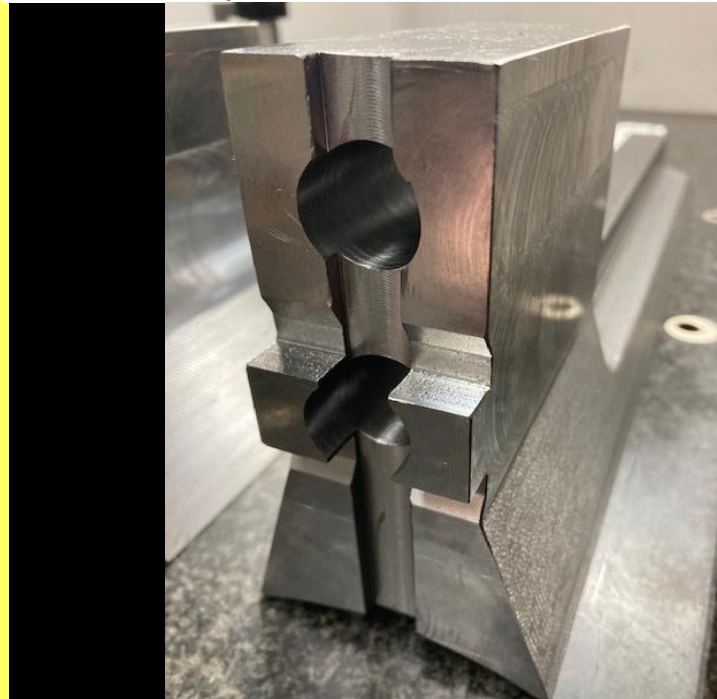
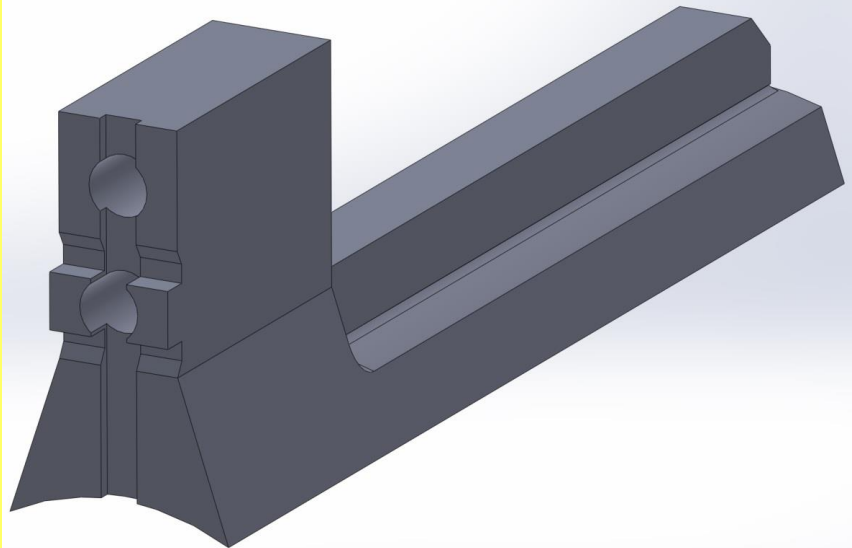

Sample Work – Engr. – Fab. - Mach.

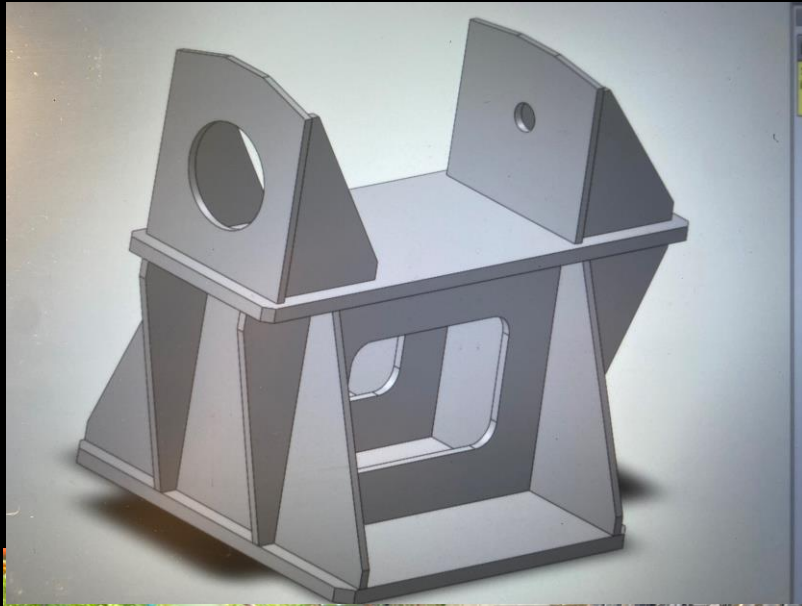

Sample Work – Engr. – Fab. - Mach.

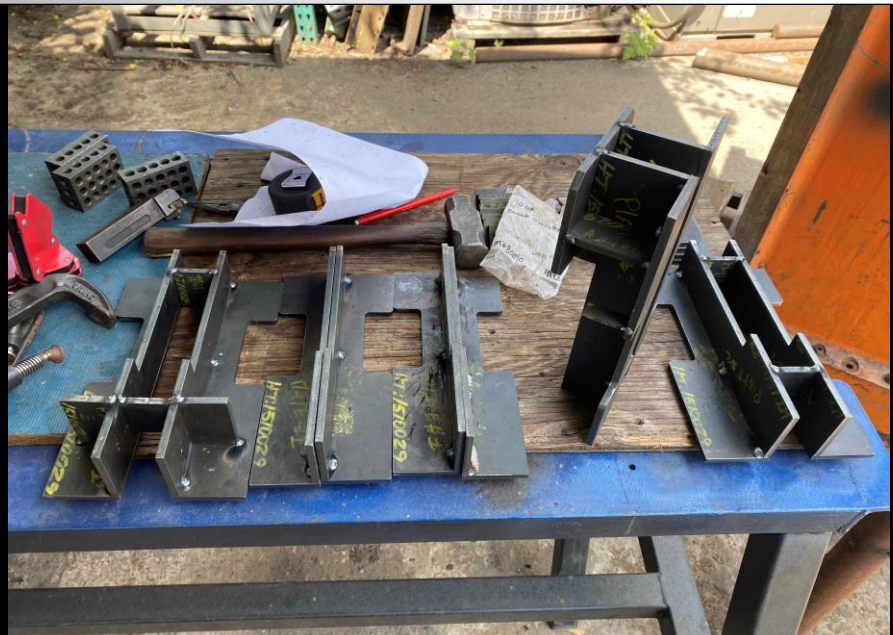
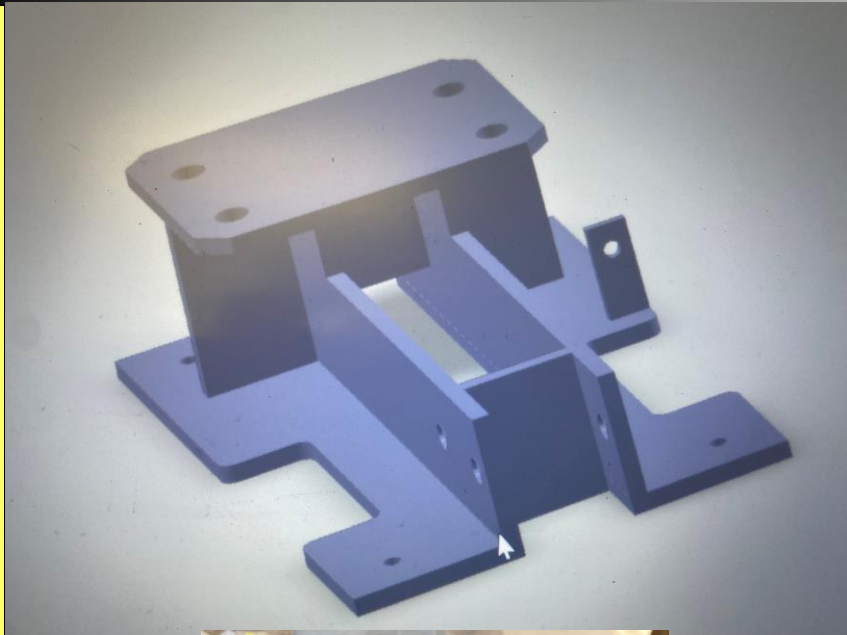

Sample Work – Fab. - Mach.

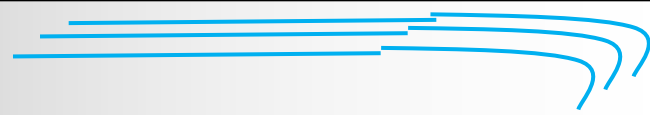

Sample Work – Engr. & Mach.

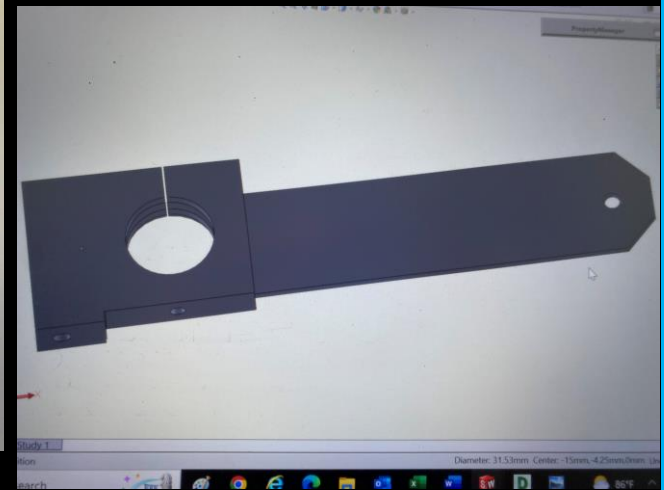
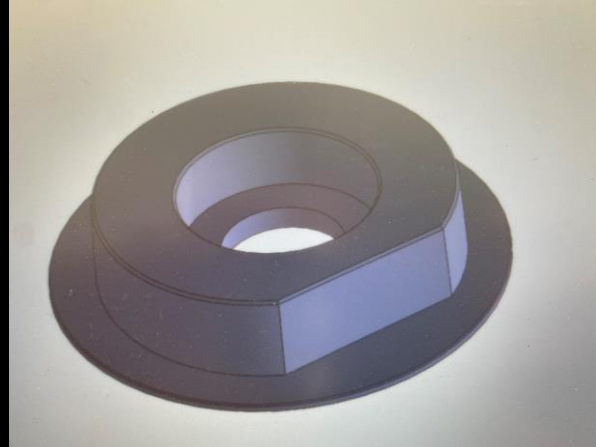
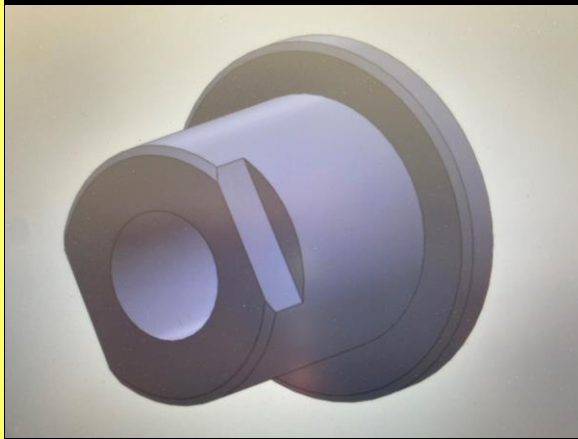
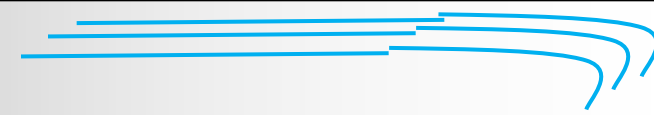

Sample Work – Engr. - Mach.

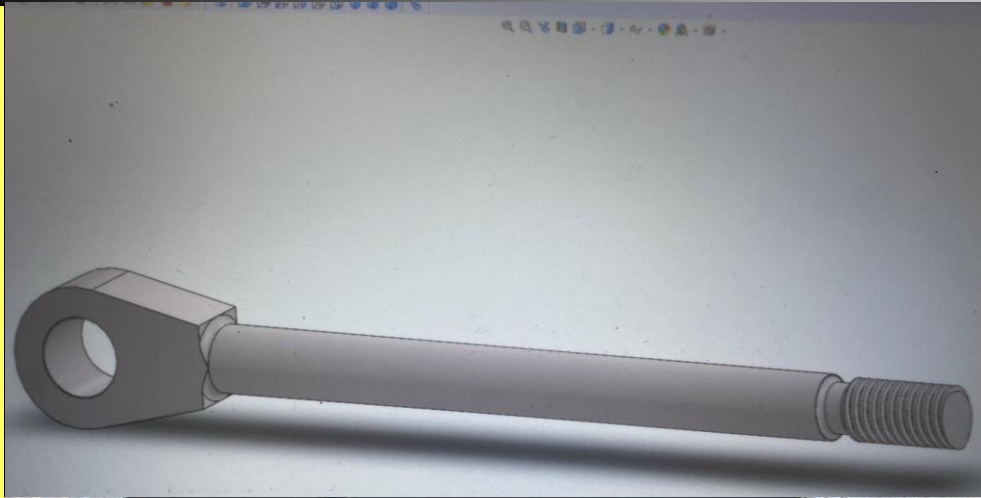
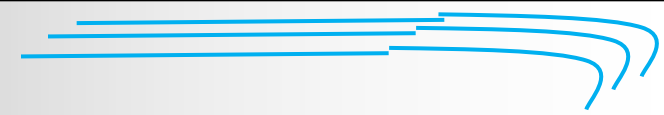

Sample Work – Mach. – Hardening

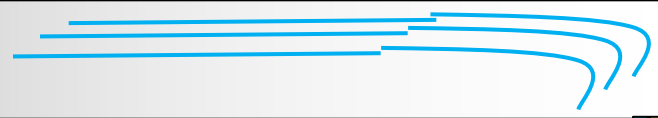

Sample Work – Mach. - Hardening



Sample Work – Engr. - Mach.



Sample Work – Engr. - Mach.

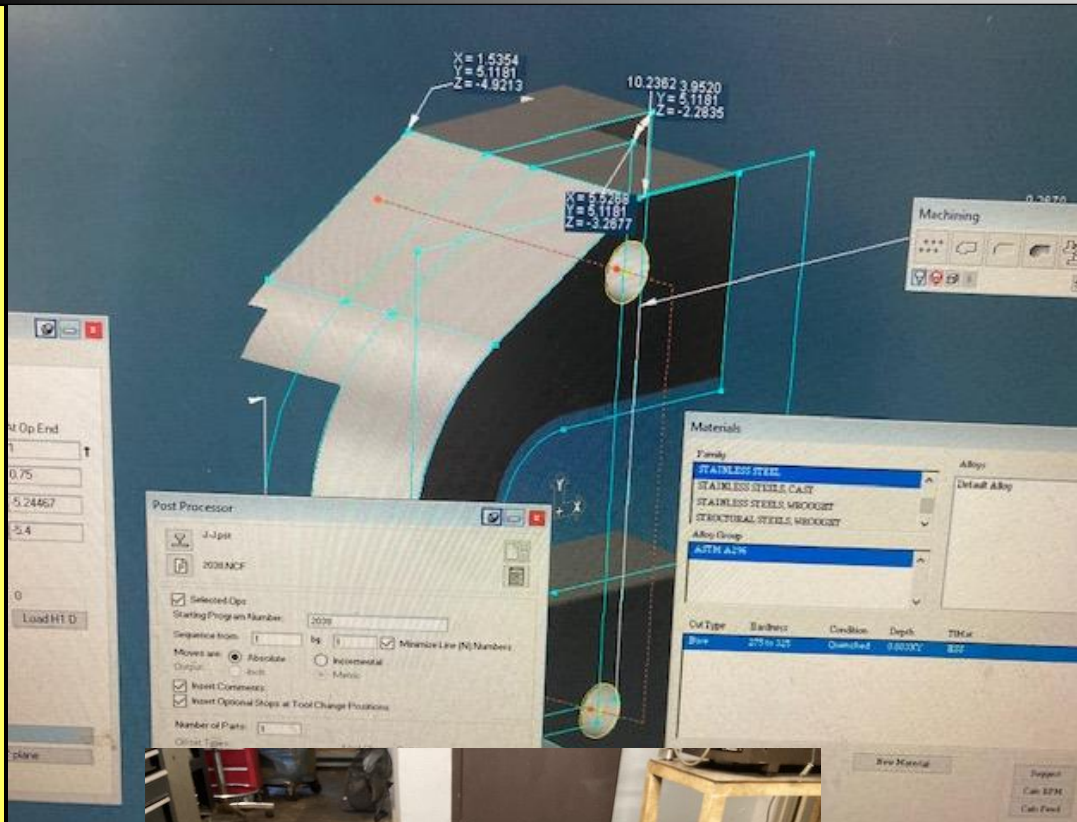

Sample Work – Engr. - Mach. – Chrome Pl.

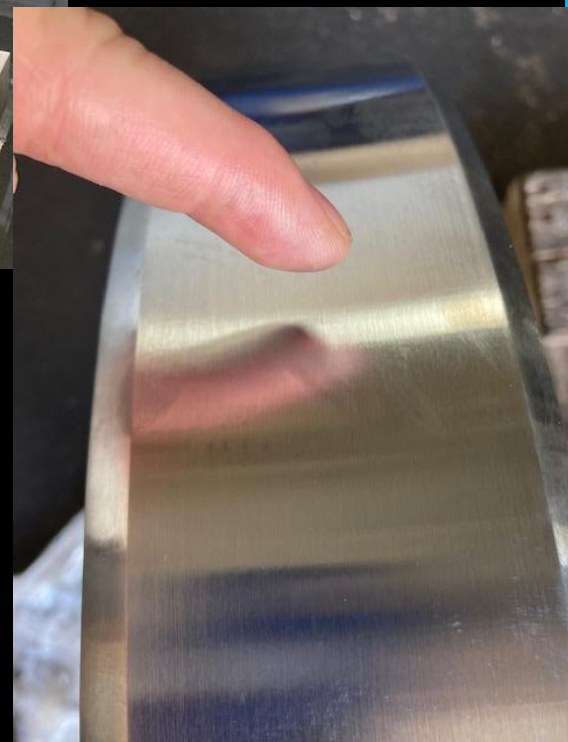
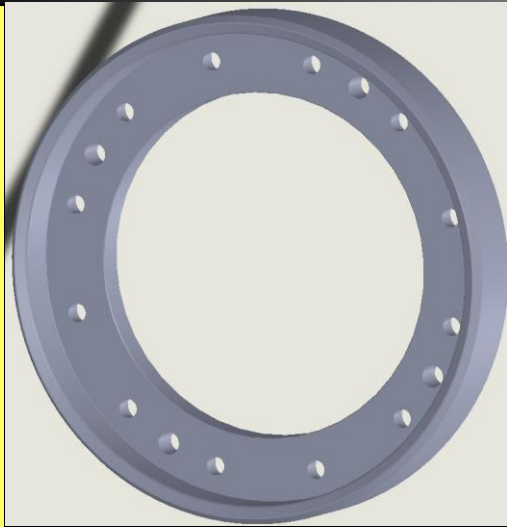

Sample Work – Mach. – Fab.



Sample Work – Mach.

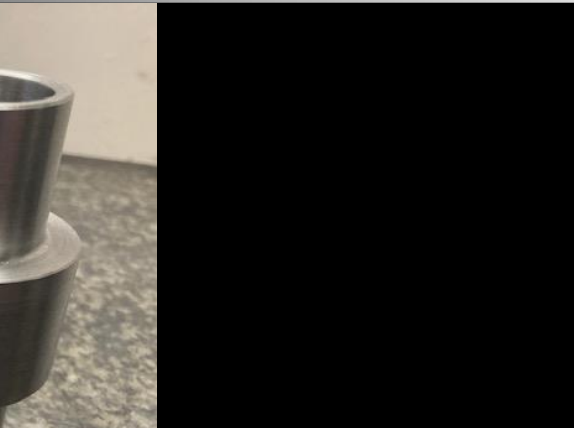

Sample Work – Mach.

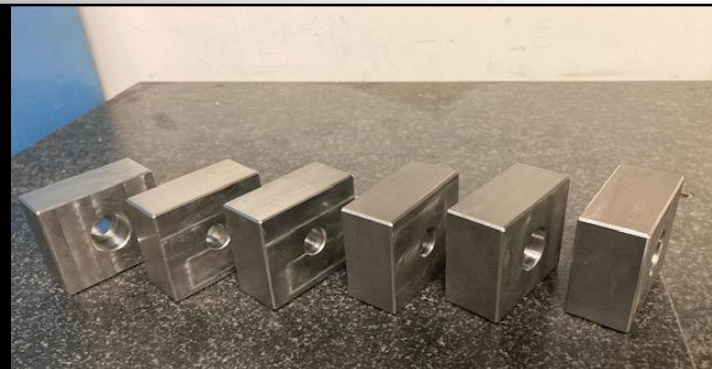
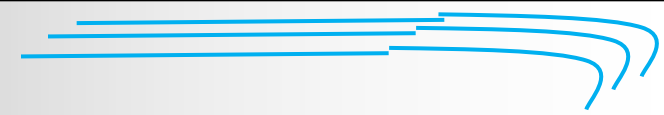

Sample Work – Mach.



Sample Work – Mach. - Nitriding

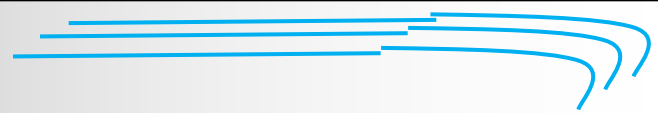

Sample Work – Engr. - Mach.

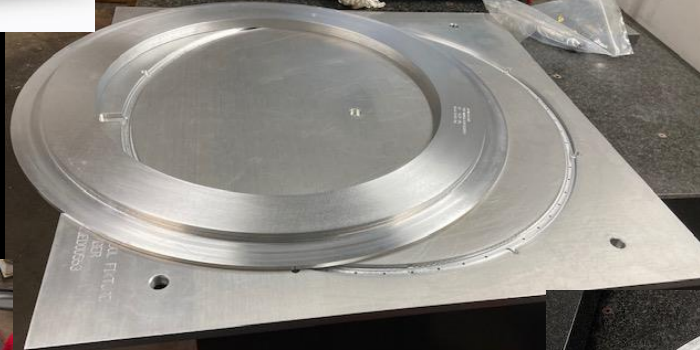
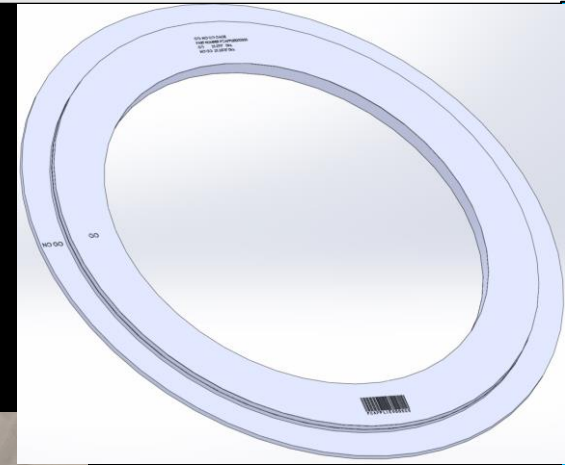
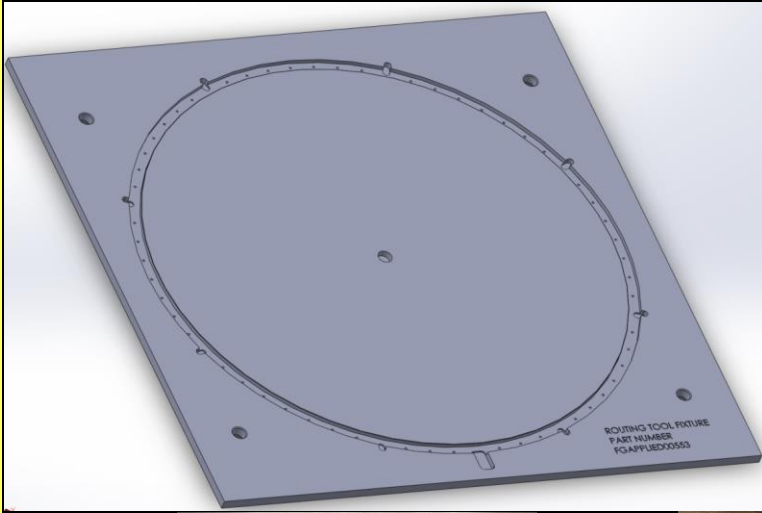
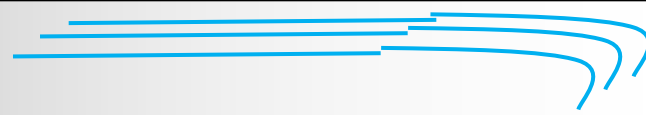

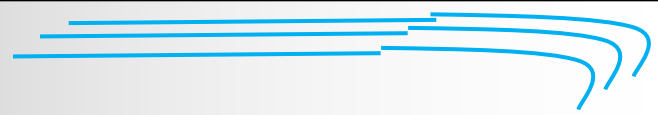

Sample Work – Mach.

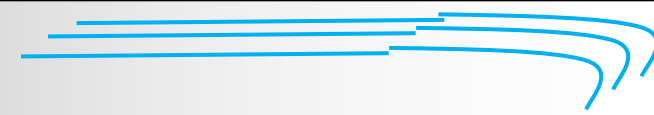

Sample Work – Mach. – Nitriding



Sample Work – Mach.



Sample Work – Mach.

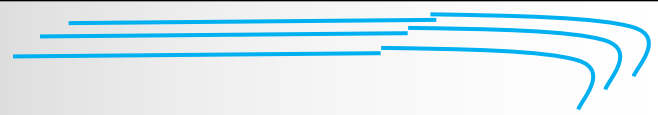

Sample Work – Mach.

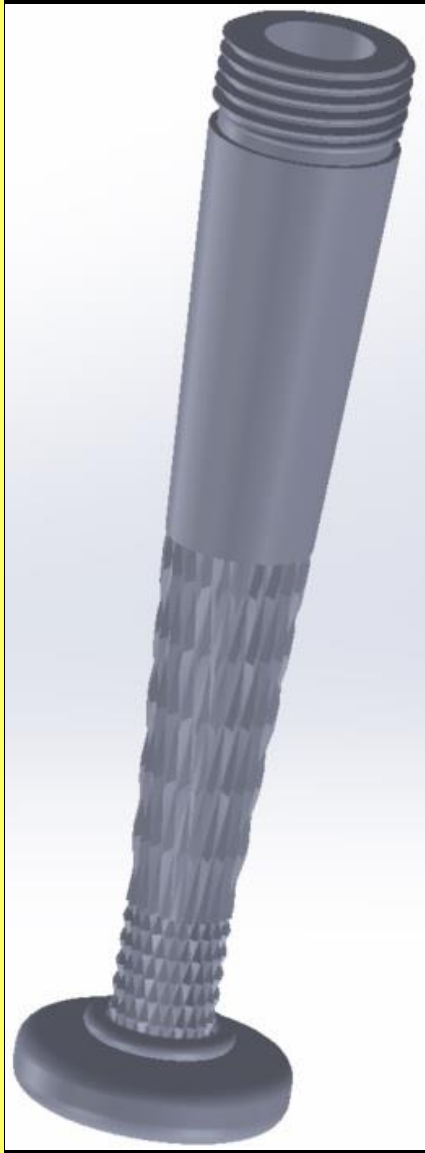

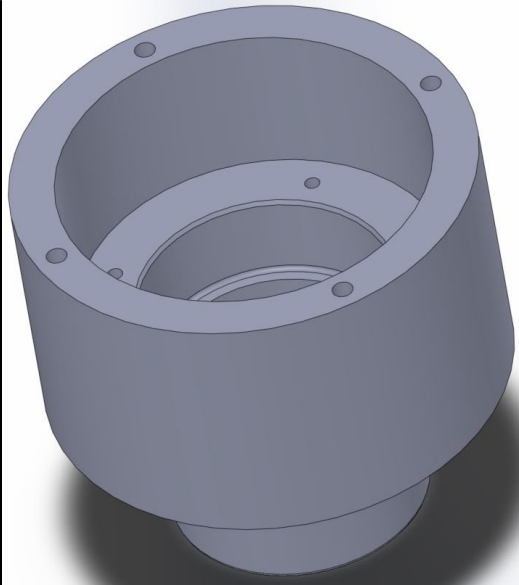

Sample Work – Mach.



Sample Work – Mach.



Sample Work – Mach.

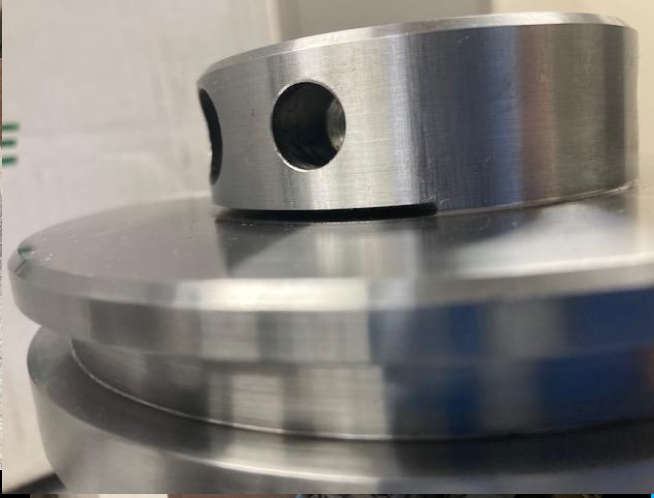
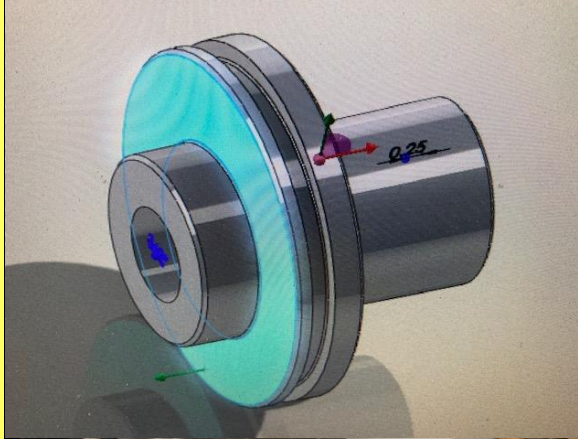

Sample Work – Mach.



Sample Work – Mach. – Fab.



Sample Work – Mach.

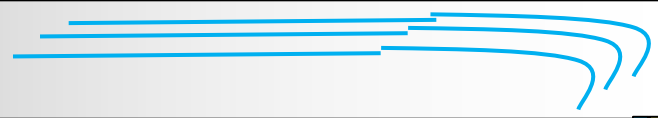

Sample Work – Mach.

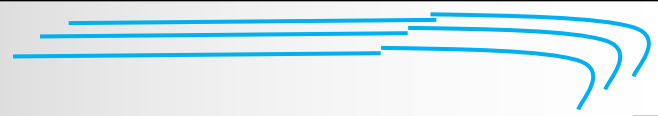

Sample Work – Mach. – Chrome Pl.



Sample Work – Mach.



Sample Work – Mach.



Sample Work – Mach.

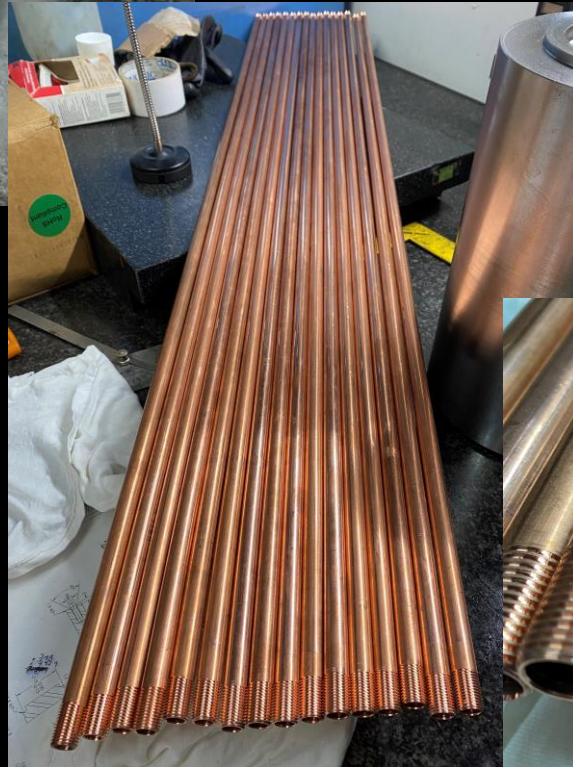
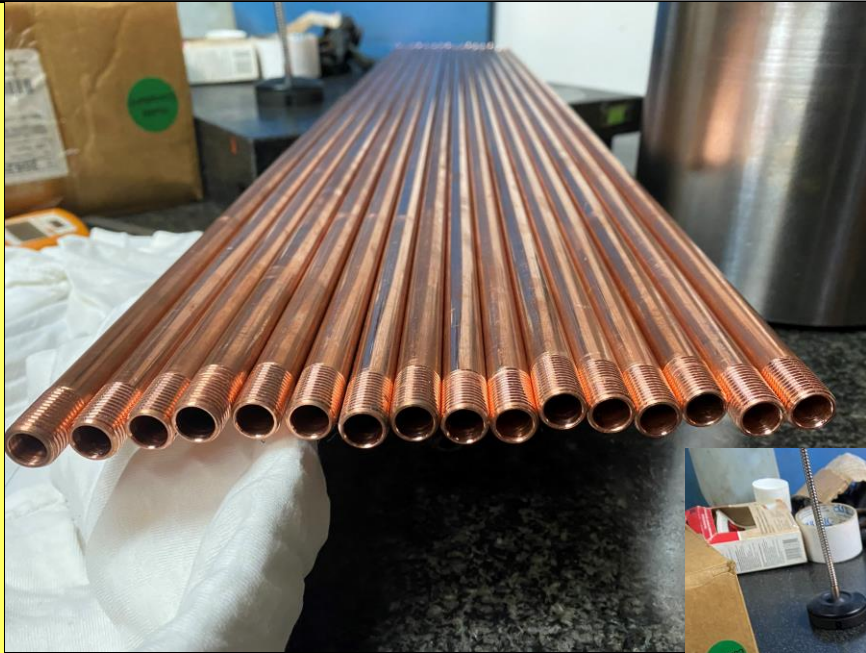

Sample Work – Mach.

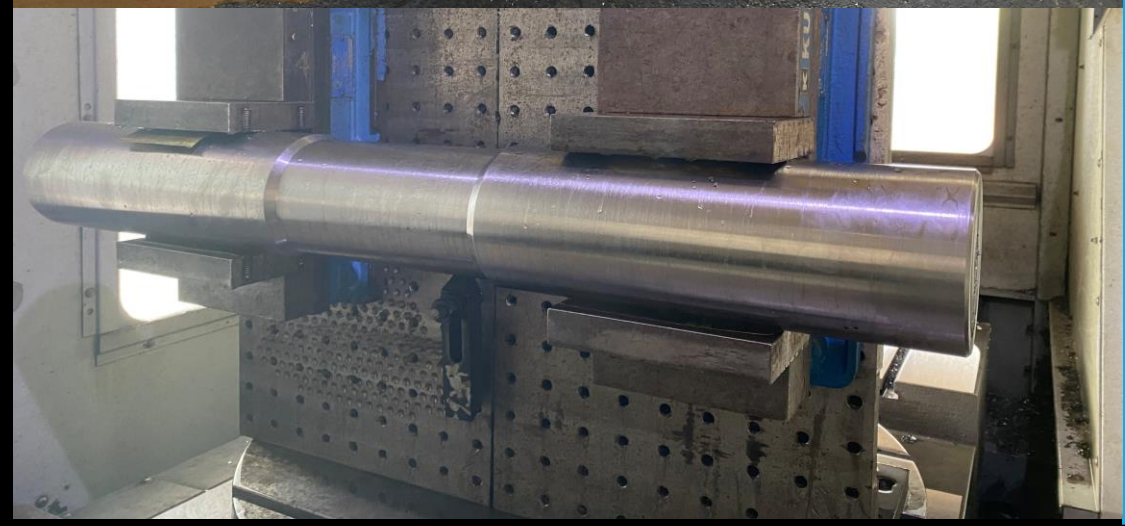

Sample Work – Mach.



ISOMETRIC VIEW

Sample Work – Engr. - Mach.

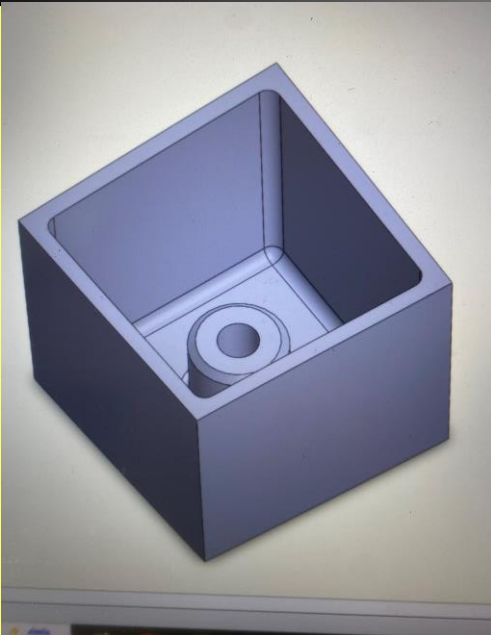
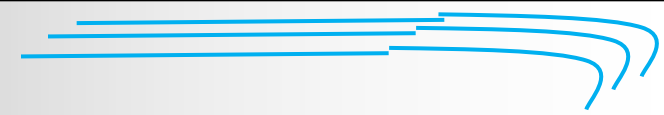

Sample Work – Mach.

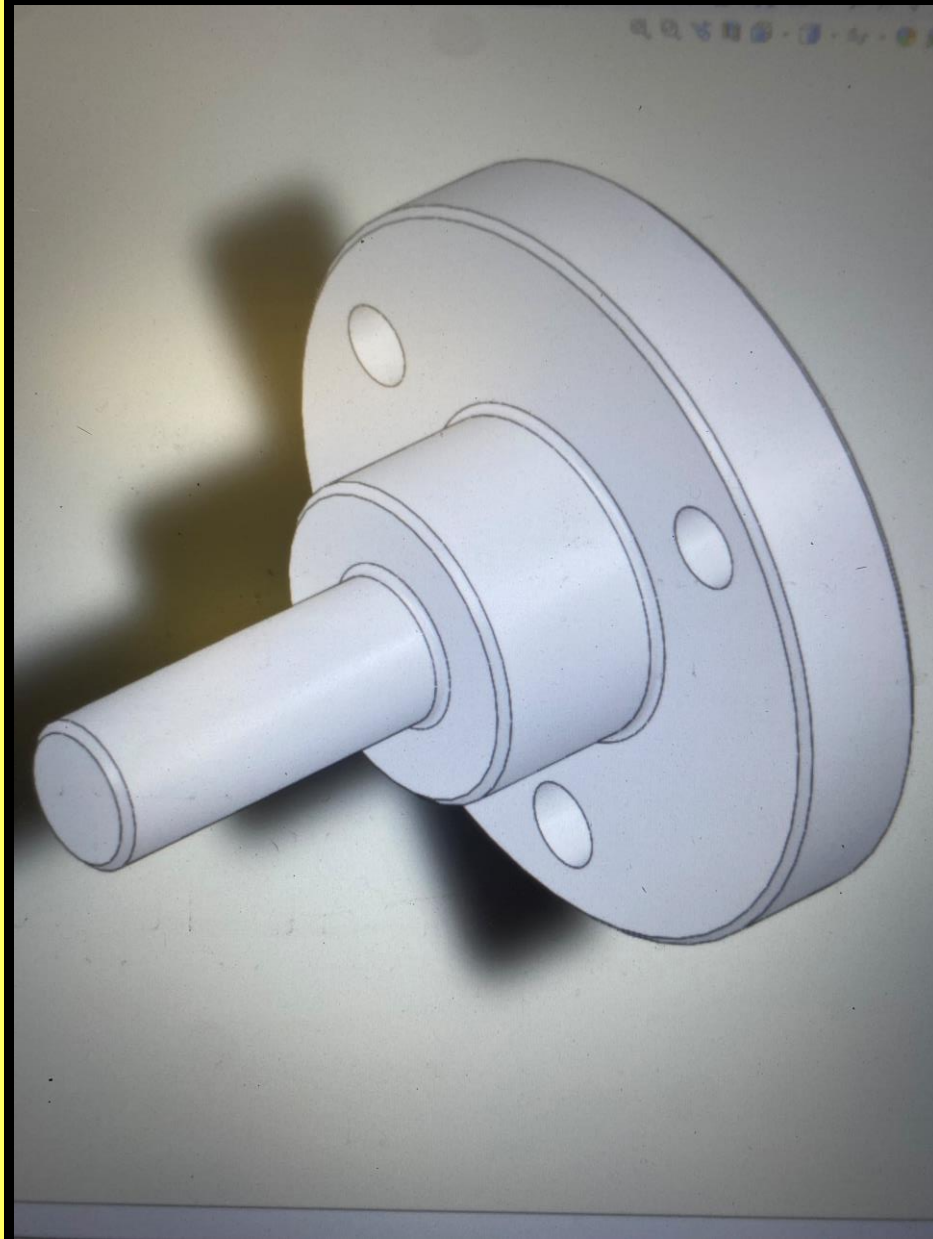
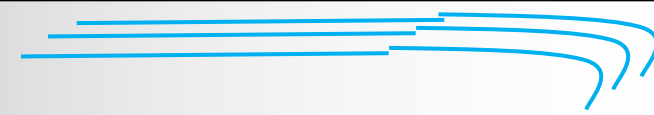

Sample Work – Mach.

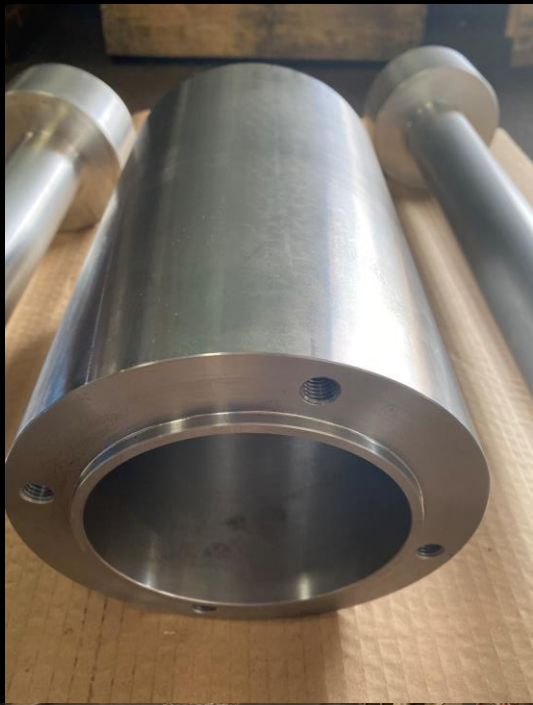

Sample Work – Engr. - Mach.

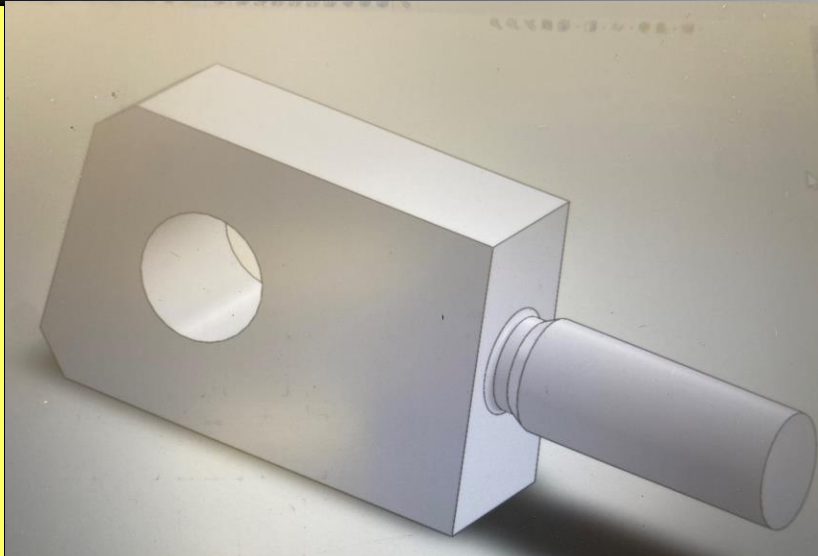

Sample Work – Mach.



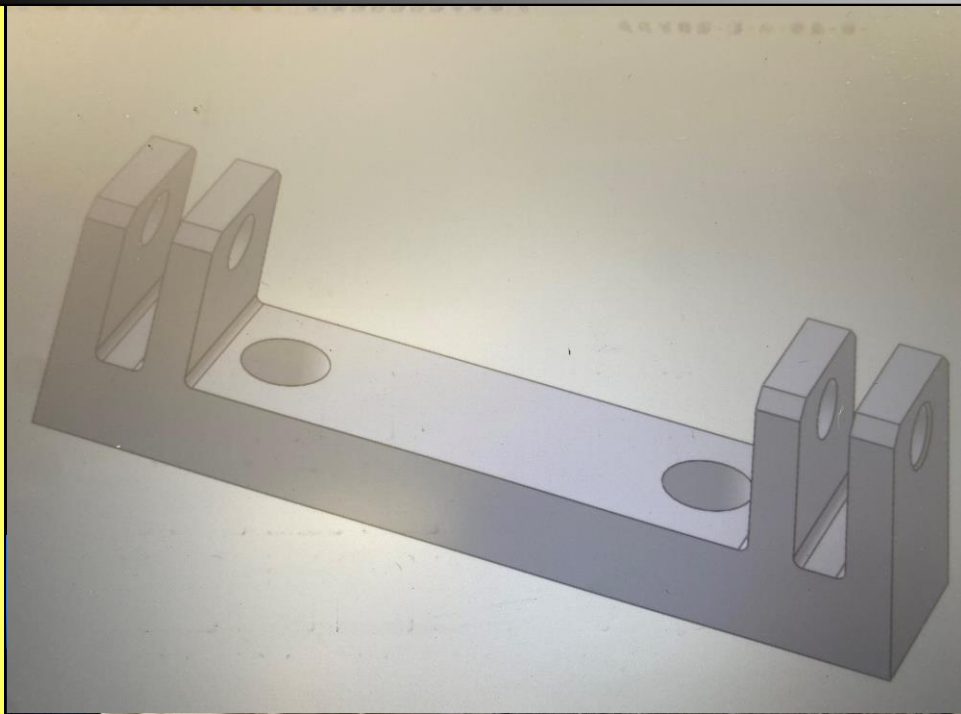

Sample Work – Engr. - Mach.

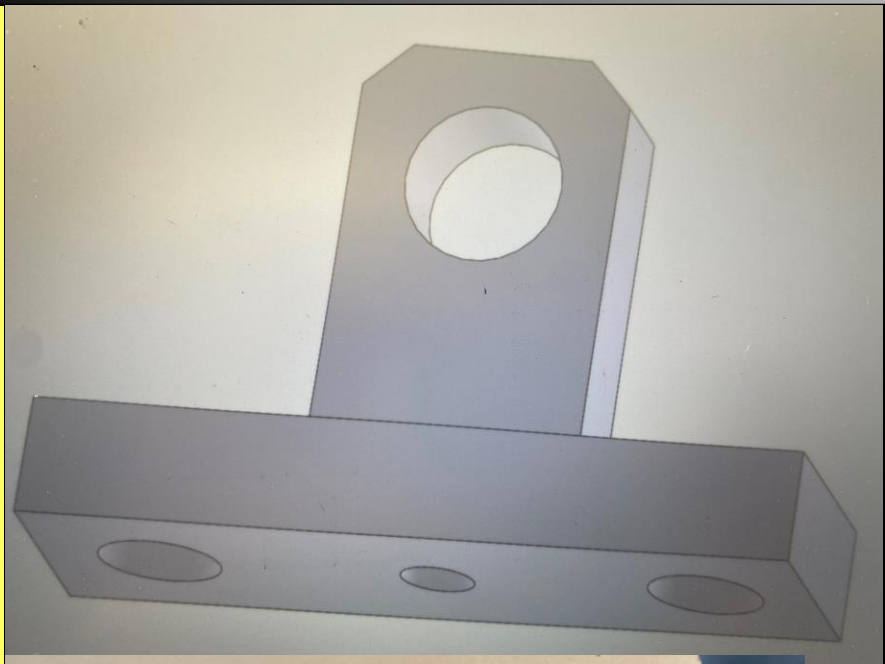

Sample Work – Engr. - Mach.

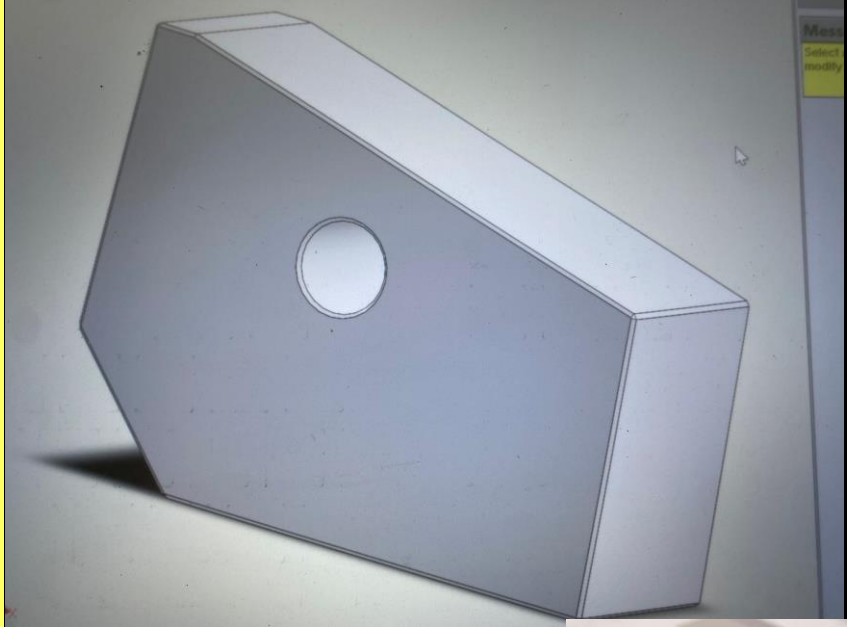

The End



Thank you